



MAKE A STATEMENT

USER GUIDE



Countries of destination:

GB - Great Britain
IE - Ireland
DE - Germany
ES - Spain

FR - France
IT - Italy
PL - Poland
NL - Netherlands

SE - Sweden
CN - China
NZ - New Zealand
AU - Australia

To contact Stoves about your appliance, please call:



Customer Care Helpline
0344 815 3740

In case of difficulty within the UK



Warranty Registration
0800 952 1065

*Please call our Customer Care team for extended warranty



Spares Store
0344 815 3745



To register your appliance online:

www.stoves.co.uk



To contact us by email:

gdhainfo@gdha.com



To register your appliance by mail:

Please complete the warranty card and return to the address supplied



Alternatively general, spares and service information is available from our website at: **www.stoves.co.uk**

Calls are charged at the basic rate, please check with your telephone service provider for exact charges

Your new appliance comes with our **12-month guarantee**, protecting you against electrical and mechanical breakdown. To register, please complete the registration form included, register online or by phone. For full terms & conditions of the manufacturer's guarantee, please refer to the website above. In addition, you may wish to purchase an extended warranty. A leaflet explaining how to do this is included with your appliance.

Our policy is one of constant development and improvement, therefore we cannot guarantee the strict accuracy of all of our illustrations and specifications. Changes may have been made subsequent to publishing.

INTRODUCTION

ACKNOWLEDGMENT

Thank you for purchasing our product. We hope you enjoy using the many features and benefits it provides.

This user guide book is designed to help you through each step of owning your new product.

Please read it carefully before you start using your appliance, as we have endeavored to answer as many questions as possible, and provide you with as much support as we can.

General information, spares and service information is available from our website.

Ensure that other people using the product are familiar with these instructions as well.

If you should find something missing from your product or have any questions that are not covered in this user guide, please contact us (see contact information inside the front cover).

European Directives



This appliance is marked according to the European directive 2012/19/EU on Waste Electrical and Electronic Equipment (WEEE).

By ensuring this product is disposed correctly, you will help prevent potential negative consequences for the environment and human health, which could otherwise be caused by inappropriate waste handling of this product. The symbol on the product indicates that this product may not be treated as household waste. Instead it shall be handed over to the applicable collection point for the recycling of electrical and electronic equipment. Disposal must be carried out in accordance with local environmental regulations for waste disposal. For more detailed information about treatment, recovery and recycling of this product, please contact your local city office, your household waste disposal service or the shop where you purchased the product

This appliance conforms to European Directive regarding Eco design requirements for energy-related products.

DECLARATION OF COMPLIANCE

When you have unpacked the oven, make sure that it has not been damaged in any way. If you have any doubts at all, do not use it: contact a professionally qualified person. Keep packing materials such as plastic bags, polystyrene, or nails out of the reach of children because these are dangerous to children.



UK ONLY GAS WARNING:

If you smell gas, Do not try to light any appliance. Do not touch any electrical switch.
Call the Gas Emergency Help line at **0800 111999**

SAFETY

WARNING

- During use the appliance becomes hot. Care should be taken to avoid touching heating elements.
- Children less than 8 years of age shall be kept away unless continuously supervised. This appliance can be used by children aged from 8 years and above and persons with reduced physical sensory or mental capabilities or lack of experience and knowledge if they have been given supervision or instruction concerning the use of the appliance in a safe way and understand the hazards involved. Children shall not play with the appliance. Cleaning and user maintenance shall not be made by children without supervision.
- Do not use harsh abrasive cleaners or sharp metal scrapers to clean the oven door glass since they can scratch the surface, which may result in shattering of the glass.
- Do not use a steam cleaner on any cooking range, hobs and oven appliances.
- Ensure that the appliance is switched off before replacing the lamp to avoid electric shock.
- Never put items directly on the base of the oven or cover the oven with foil, as this can cause the base element to overheat.
- When the oven is first switched on, it may give off an unpleasant smell. Please use the conventional cooking function at 250°C for 90 minutes to clean oil impurities inside the cavity.
- Do not allow children to go near the oven when it is operating, especially when the grill is on.
- The means for disconnection must, be incorporated in the fixed wiring in accordance with the wiring specifications
- An all-pole disconnection means must be incorporated in the fixed wiring in accordance with the wiring rules in force
- If the supply cord is damaged, it must be replaced by the manufacturer, its service agent or similarly qualified persons in order to avoid a hazard.

CAUTION

- This appliance must not be installed behind a decorative door in

order to avoid overheating.

- The cooking process has to be supervised. A short term cooking process has to be supervised continuously.

- **Fire Safety Advice**

If you do have a fire in the kitchen, don't take any risks - get everyone out of your home and call the Fire Brigade.

If you have an electrical fire in the kitchen:

- Pull the plug out, or switch off the power at the fuse box - this may be enough to stop the fire immediately
- Smother the fire with a fire blanket, or use a dry powder or carbon dioxide extinguisher
- Remember: never use water on an electrical or cooking oil fire.

- **Other Safety Advice**

- Servicing should be carried out only by authorised personnel.
- Do not operate the appliance without the glass panel correctly fitted.
- There is a risk of electric shock, so always make sure you have turned off and unplugged your appliance before starting. Always allow the product to cool down before you change a bulb.
- Do not modify the outer panels of this appliance in any way.
- This appliance must be earthed.
- The appliance must never be disconnected from the mains supply during use, as this will seriously affect the safety and performance, particularly in relation to surface temperatures becoming hot and gas operated parts not working efficiently. The cooling fan (if fitted) is designed to run on after the control knob has been switched off.



Warning for Pyrolytic Ovens

- Before carrying out a Pyrolytic self-cleaning function or the First Use function, please remove from the oven cavity:
 - Any excess food residues, oil or grease spills / deposits.
 - Any removable objects (including shelves, side rails and grill pans provided with the product)
- Loose food residues, grease and meat juices may catch fire during the pyrolytic cleaning cycle. Wipe down the oven and remove any loose food residue prior to starting the pyrolytic cleaning cycle.
- During self-cleaning, the oven heats up to approx. 450°C.
- The appliance will become very hot on the outside during the pyrolytic cleaning cycle.
- Never hang combustible objects, e.g. tea towels, over the door handle.
- Do not lean anything against the front of the oven.
- Never touch the appliance door.
- Keep children at a safe distance when the oven is in the Pyrolytic cleaning cycle.
- Allow the appliance to cool down.
- The oven light in the cooking compartment does not come on during the Pyrolytic cleaning mode.
- For your safety, the oven door locks automatically. The oven door cannot be opened again until the cooking compartment has cooled. Never force open the appliance door or move the locking latch by hand.
- Never let non-stick baking trays and tins go through the Pyrolytic cleaning cycle. The non-stick coating on baking trays and tins is destroyed and noxious gases are released.
- The pyrolytic cleaning cycle burns off residues from roasting, grilling or baking and you only need to wipe the ashes from the cooking compartment once the appliances has cooled sufficiently.
- It is usually sufficient to only clean the cooking compartment every two to three months.

USING YOUR APPLIANCE

Getting to know your product

Note: Your appliance layout may differ depending on the model.

Control Panel

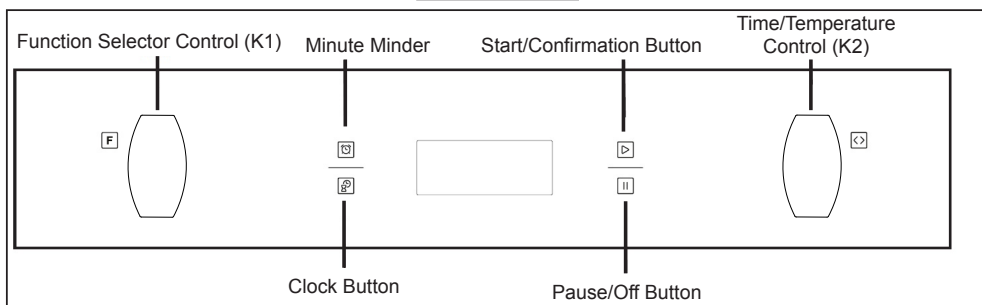

Oven / Grill functions

Note: Your oven may not have all of the functions shown here. We recommend for best cooking results, please preheat for 15 minutes.

Symbol	Function Description
	Oven Lamp:- Can be operated on its own and will also come on when any oven function is selected except ECO and Pyrolytic functions.
	Defrost:- Can be used to gently defrost frozen foods, This setting can also be used to help dough to rise faster than at room temperature.
	Base Heat:- Ideal for when additional base heat is required in the cooking process, e.g. the base heat can be used to provide additional browning for dishes such as pizza, pies and quiche. The temperature can be set within the ranges of 60-120°C. The default temperature is 60°C
	Conventional Cooking:-The top and bottom elements work together to provide traditional cooking and is ideal for roasting. The temperature can be set within the range of 50-250°C. The default temperature is 220°C.
	Fan Assist:- Combination of the fan and both top and bottom heating elements provide even heat distribution around the food. Dishes are lightly browned on the outside and still moist on the inside. Note: This function is suitable for grilling or roasting big pieces of meat at a higher temperature. The temperature can be set within the range of 50-250°C. The default temperature is 220°C.
	Top Heat:- is ideal for browning off the tops of food as it is not as intense as the grilling function, Provides additional browning for dishes like lasagna or cauliflower cheese, Use this function towards the end of the cooking cycle. The temperature can be set within the range of 150-200°C. The default temperature is 180°C
	Fanned Grill:- The fan forces air around the food and is ideal for thinner foods such as bacon, fish and gammon steaks. Foods require less turning. Use this function with the oven door closed. The temperature can be set within the range of 180-240°C. The default temperature is 210°C.
	Fanned Oven:- The even temperature in the oven makes this function suitable for batch baking, or batch cooking foods. The temperature can be set within the range of 50-240°C. The default temperature is 180°C.
	Radiant Grill:- The centre area under the grill becomes hot and is ideal for toasting, and grilling meats such as sausages, chops and steaks The temperature can be set within the range of 180-240°C. The default temperature is 210°C.
Pyrolytic Mode	Pyrolytic function: When the function set to Prolytic Mode, LED display "PyR". The default temperature is 450°C. The timer can be set 1:30 or 2:00 hours
	Combination of the top and bottom heating elements with intermittent fan operation to provide even heat distribution around the food. The temperature can be set within the range of 50°C to 250°C. The default temperature is 160°C.

Oven

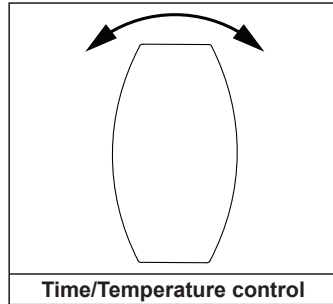
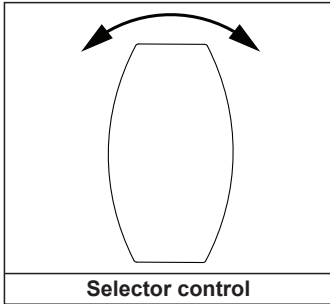

Cooling Fan

When cooking is finished, paused, or if the center oven temperature is over 75°C, the cooling fan will continue working for 15 minutes. When the center oven temperature drops below 75°C, the cooling fan will stop.

To use your appliance

To select a Cooking Function and Cooking Temperature

1. Begin by turning K1 to the desired cooking function. The selected function will be shown on the appliance display.
2. Rotate K2 to select the desired cooking temperature. This can be adjusted during use. Note that some functions (light only, Defrost etc) will not have a temperature option.
3. Press the Start/Confirmation to set the function and temperature.

Note: Press the Pause/Off button once to pause cooking. Press the Pause/Off button twice to cancel cooking.

To activate and deactivate the Child Lock function

Child lock can be activated to stop the product from being accidentally turned on.

1. Press and hold the Start/Confirmation and the Pause/Off button until a beep is heard. A lock symbol will appear on the display. This indicates that the Child Lock function has been activated.
2. To deactivate, press and hold the Start/Confirmation and the Pause/Off button until a beep is heard. The lock symbol will disappear on the display and the appliance can be used as normal.

Clock/Programmer

Setting the Time of Day

This can be done when the appliance is first connected to the power supply or at any point afterwards providing the oven is in standby (i.e not operating)

The clock is displayed as "hh:mm" and is a 24 hour clock.

1. Press the Clock Button once, and the hour figures will begin to flash.

2. Rotate K2 to adjust the hour figure. The numbers go from 0-23.
3. Press the clock button to set the hours and move onto the minutes.
4. Rotate K2 to adjust the minutes figure. The minutes go from 00-59.
5. Press the clock the button to finish setting the clock. The “.” will begin to flash. This signals that setting the Time of Day has been successful.

Note: If the clock is not set when first connected to the power, it will display 00:00.

Setting the Minute minder

This cannot be set when cooking functions are being selected.

The clock is displayed as “h:mm”.

1. Press the Minute Minder button. The display should show “0:00” and the Minute Minder light will be lit on the display.
2. Rotate K2 to adjust the hour figure. The numbers go from 0-9.
3. Press the Minute Minder button to set the hours and move onto the minutes.
4. Rotate K2 to adjust the minutes figure. The minutes go from 00-59.
5. Press the Start/Confirmation button to finish setting the minute minder. The Minute Minder will then begin to count down.
6. When the Minute Minder has finished counting down the appliance will beep 10 times. This signals the end of the minute minder.

Note: The Minute Minder can be cancelled during set-up by pressing the Pause/Off button. The Minute Minder can be cancelled at any point once it has been set by pressing the Pause/Off button twice. Resetting the minute minder, allows the user to amend the desired time.

Semi-Automatic Cooking (To Use Your Appliance)

1. Begin by turning K1 to the desired cooking function. The selected function will be shown on the appliance display.
2. Adjust K2 to change the cooking temperature. Note that some functions (light only, Defrost etc) will not have a temperature option.
3. Press the Start/Confirmation to set the function and temperature.
4. Adjust K1 to set the cooking time (if not adjusted, the default cooking time is set to 9 hours)
5. Press the Start/Confirmation button to confirm cooking time.
6. To change cooking temperature or cooking time, simply adjust the relevant knob to the desired setting and press the Start/Confirmation button to confirm your choice.
7. When cooking has finished, the appliance will beep 5 times.

Note: Press the Pause/Off button once to pause cooking. Press the Pause/Off button twice to cancel cooking.

Fully Automatic Cooking (To Use Your Appliance)

1. Press the Clock Button once, and the hour figures will begin to flash.
2. Rotate K2 to adjust the hour figure. The numbers go from 0-23.
3. Press the clock button to set the hours and move onto the minutes.
4. Rotate K2 to adjust the minutes figure. The minutes go from 00-59.
5. Now adjust K1 to select the desired function.
6. Press the Start/Confirmation button to set the function.
7. Adjust K1 and K2 in order to set the cooking time and cooking temperature.
8. Press Start/Confirmation button to confirm cooking time and cooking temperature. The Fully Automatic symbol will appear on the display, which looks like a sand timer. The Oven is now set to Fully Automatic, and will begin cooking at the time set.

9. A beep will sound when the oven begins its cook cycle. The Fully Automatic symbol will disappear. The oven will now have the same functionality and operations as Semi-Automatic cooking.
10. When cooking has finished the appliance will beep 5 times.

Note: Press the Pause/Off button once to pause cooking. Press the Pause/Off button twice to cancel cooking. Lamp and Defrost functions cannot be set in Fully Automatic mode.

Notes

1. The Oven lamp will be on for all functions(except ECO and Pyrolytic functions).
2. Energy saving mode is activated automatically when the oven has not been operating for 10 minutes. The display will go off. To manually enter Energy Saving mode, press and hold the Start/Confirmation button for 3 seconds.

Soft Closing Door (If fitted)

The door can be paused at any angle greater than 30°.

The door will close slowly under the action of the damper, if it is less than or equal to an angle of 30°.

Please do not close the door vigorously.

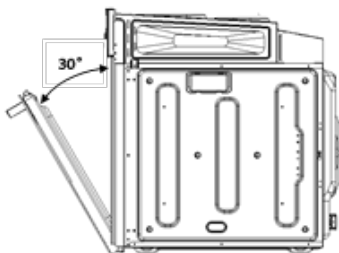

Catalytic Oven liners (If fitted)

Some oven specifications have catalytic oven liners fitted to the sides of the oven, you can easily tell if they are fitted because the panel is a light grey soft touch enamel. This enamel is special and partly cleans itself. This does not stop all marks on the lining, but helps to reduce the amount of manual cleaning needed.

These panels work best when the oven is heated above 200°C. If you do most of your cooking below this temperature, occasionally wipe the panels with a lint free cloth and hot soapy water. The panels should then be allowed to dry naturally and the oven heated at 200°C for about one hour. This will make sure that the panels are working effectively.

Do not use harsh abrasives or chemicals on this soft enamel.

Removing the door from oven (If fitted)

Disassembly of oven door components

1. To remove the door, open the door to the maximum angle. Then pull the catch at the door hinge backward.

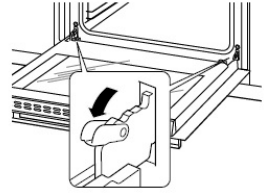

2. Close the door to an angle approximately 30°. Hold the door with one hand on each side. Lift up and slowly pull the door out from the oven.

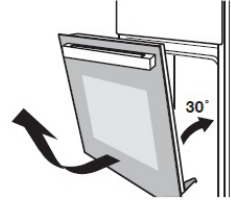

3. Open the door rotation bracket assembly, refer the action in the following picture.



4. Lift up the door outer glass and pull it out, then take the door middle glass out in the same way.

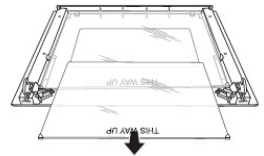
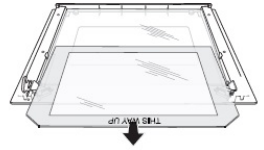

To reassemble, follow the instructions in reverse, ensuring the glass is re-installed the right way up.

WARNING: Do not forcibly pull on the oven door as this could result in the glass shattering during the dismantling process

WARNING: The hinge springs could loosen, causing personal injury.

WARNING: Do not lift or carry the oven door by the door handle.

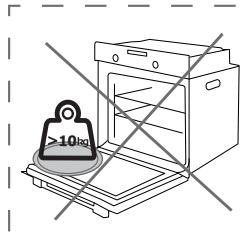

Accessories

Wire shelf: For grill, dishes, cake pan with items for roasting and grilling.

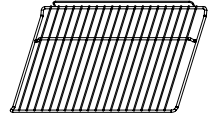

Slider bracket: For cooking larger size food, these shelf support rails on the right and left sides of the oven can be removed.

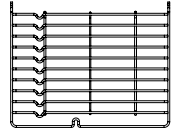

Grill pan: For cooking large quantities of food such as moist cakes, pastries, frozen food etc, or for collecting fat/ spillage and meat juices.

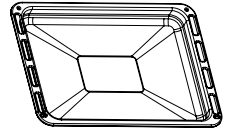

Telescopic runner (if fitted): Some models might come with telescopic runners to facilitate the use of oven. These telescopic runners and slider brackets could be disassembled by unscrewing the screws used to fix it.

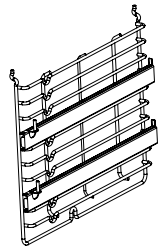

Shelf placement warning:

To ensure the oven shelves operate safely, correct placement of the shelves between the side rail is imperative. Shelves and the grill pan can only be used between the first and fifth layers.

The shelves should only be used in the right direction as it ensures that trays and hot food items do not slide if the shelves are moved.

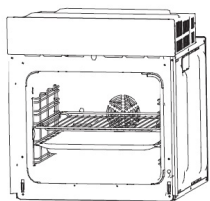

OR

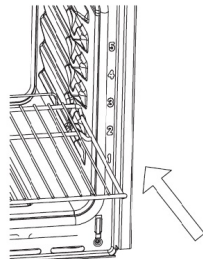
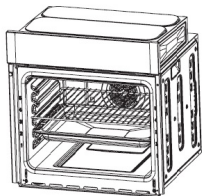

Removing Shelf Runners

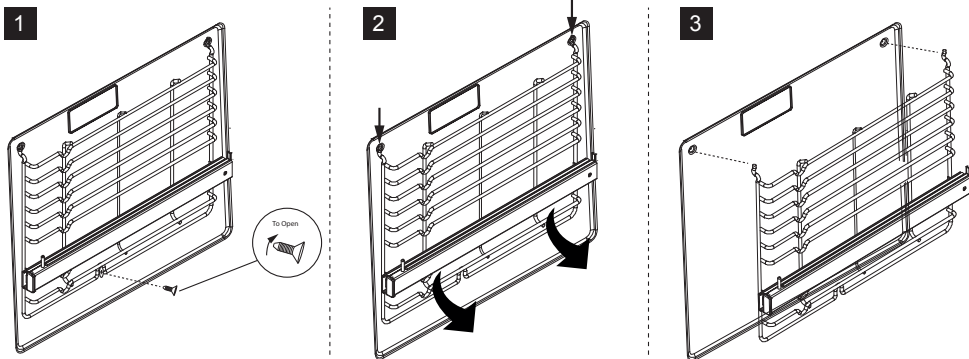

Standard shelves

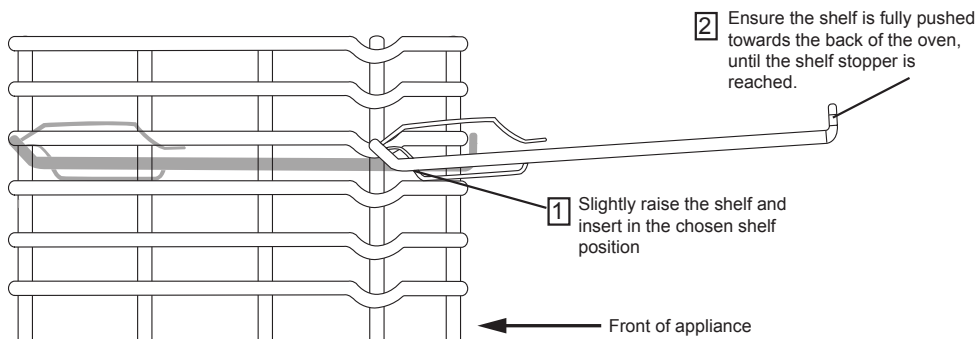

The oven shelves can also be hooked onto the shelf runners

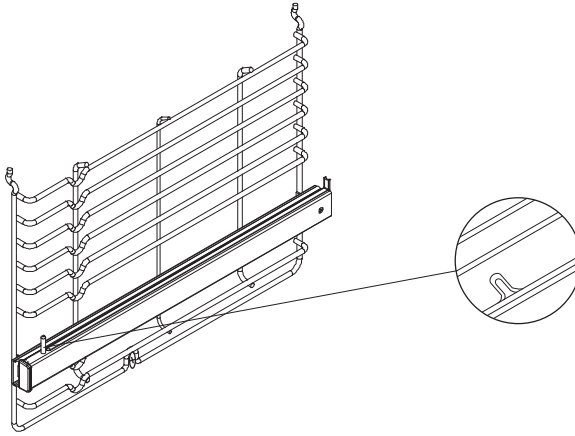

Before removing the shelves completely, please make sure that the shelf is unclipped from the retaining tabs.

BULB REPLACEMENT

Risk of electric shock!

Glass cover

You must replace a damaged glass cover. Suitable glass covers may be obtained from the after-sales service.

For replacement, process as follows:

1. Disconnect power from the mains outlet or switch off the circuit breaker of the unit's mains outlet.
2. Unscrew the glass lamp cover by turning it counter-clockwise (note, it may be stiff) and replace the bulb with a new one of the same type.
3. Screw the glass lamp cover back in place.

Note: Only use 25-40W/220V-240V, T300°C halogen lamps

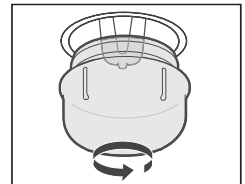

CLEANING YOUR APPLIANCE

Do's

Note: Always switch off your appliance and allow it to cool down before you clean any part of it.

Note: Please take extra care when cleaning over the symbols on the control panel, as this can lead to them fading.

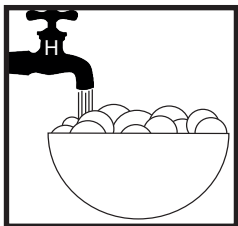

- Warm, soapy water

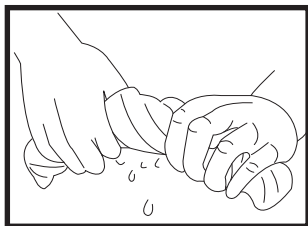

- Clean, wring out cloth

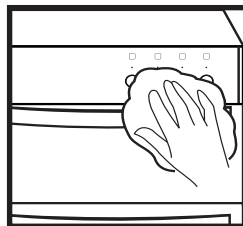

- Wipe with damp cloth
- Dry with a soft cloth

Tips: Some foods can mark or damage the metal or paint work e.g.; Vinegar, fruit juices and salt. Always clean food spillages as soon as possible.

Dont's

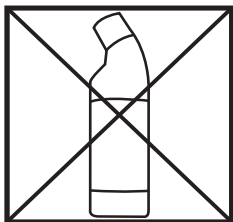

- Undiluted bleaches
- Chloride products

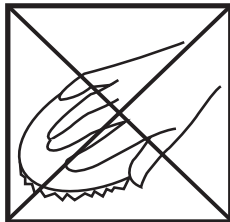

- Wire Wool
- Abrasive cleaners
- Nylon pads
- Steam cleaners

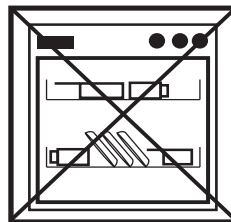

- Do not place in the dishwasher:
- Cast iron griddle
 - Pan supports

IT IS IMPORTANT TO CLEAN YOUR APPLIANCE REGULARLY AS A BUILD UP OF FAT CAN AFFECT IT'S PERFORMANCE OR DAMAGE IT AND MAY INVALIDATE YOUR GUARANTEE.

IN ADDITION TO THE ABOVE, DO NOT USE METAL SCRAPERS TO CLEAN THE OVEN DOOR GLASS.

We offer a great range of cleaning products and accessories for your appliance.
To shop, please visit our website located at the front of this User Guide.

CLEANING YOUR APPLIANCE

Before Using the Pyrolytic Cleaning Function

Please read the warning section prior to using the Pyrolytic cleaning function.

The wire selves supporting the runners and grill pan, are not suitable for the pyrolytic cleaning function.

Take them out of the cooking compartment prior to using the pyrolytic self-cleaning function.

Once the Pyrolytic function has started, the door will be locked and cannot be opened until the cleaning cycle has finished and the oven has cooled down. The door will unlock automatically.

After the Pyrolytic self-cleaning function has finished

Once the cooking compartment has cooled down and the door can be opened, wipe out the ash that has been left from the pyrolytic cleaning process and replace the oven furniture.

TECHNICAL DATA

Electric Built In

Electrical supply / Load		
Appliance Size (cm)	Electrical supply	Load (kW)
60 Pyrolytic Oven	220 - 240V ~ 50Hz	3.2

For the specific power rating of your model, refer to the data badge on the front frame of your appliance.

WARNING: This appliance must be earthed.